

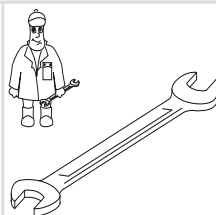

Gebr. Becker GmbH
Hölker Feld 29-31
D-42279 Wuppertal

Wartung
Maintenance
Entretien
Manutenzione
Mantenimiento



	Pos.	Menge ²⁾ Quantity Quantité Quantità Cantidad	Bestell-Nr. Ident No. No. Identification No. Identificazione No. de pedido	Bezeichnung Description Designation Designazione Descripción
U 4.250	...	1	549000 26400	Dichtungssatz, Complete set of seals, Jeu de joints, Kit di guarnizioni, Junta completa
	5	SATZ (KIT)	900507 00003	Schieber, Rotor Vane, Palette, Empujador
	83	2	965415 00000	Luftentölelement, Oil separating element, Element separation huile, Cartuccia separatore olio, Elemento de desaceitar de aire

²⁾ erforderliche Bestellmenge / necessary order quantity / quantité nécessaire / quantità di ordinazione necessari / cantidad necesario



Ersatzteilliste
Spare parts list
Liste de pièces de rechange
Listino pezzi di ricambio
Lista de piezas de recambio
Lista de peças sobresselentes
Reserveonderdelenlijst
Reservedeliste
Reservdelista

Reservedeliste
Varaosaluettelo
Wykaz części zamiennych
Seznam náhradních dílů
Tartalékalkatrész lista
Κατάλογος ανταλλακτικών
Перечень запасных частей
备用零件目录
スペアパーツリスト

U 4.250

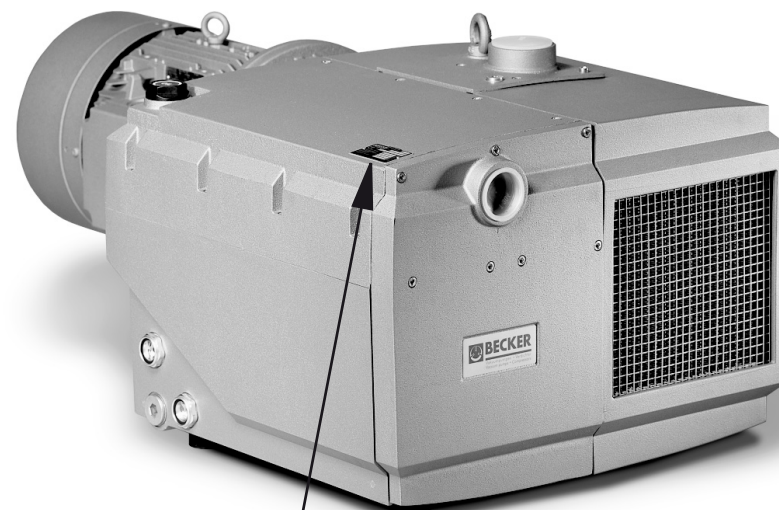

28000026500 09/2008

Index-F

 SERVICE	 D-42279 Wuppertal www.becker-international.com	year <input type="text" value="XXXX"/>	Index Option
	No <input type="text" value="F"/>	<input type="checkbox"/> Germany	
	type <input type="text" value="U 4.250-XX"/>	<input type="checkbox"/> Germany	
	frequency <input type="text" value="XXXX"/> Hz	<input type="checkbox"/> Germany	
	speed <input type="text" value="XXXX"/> min ⁻¹	<input type="checkbox"/> Germany	
	power required <input type="text" value="XXXX"/> kW	<input type="checkbox"/> Germany	
	inlet capacity <input type="text" value="XXXX"/> m ³ /h	<input type="checkbox"/> Germany	
	max. vacuum <input type="text" value="XXXX"/> mbar	<input type="checkbox"/> Germany	

D Service:
Tel: +49 (0)202 697-171
Fax: +49 (0)202 64 44 74
E-Mail: info@becker-international.com
 www.becker-international.com



U 4.250

Pos.	Bestell Nr.	Beschreibung
...	549000 26400	DICHTUNGSSATZ ¹⁾
1	000101 26500	GEHÄUSE
3	020000 26500	KOLBEN
5	900507 00003	SCHIEBER, KUNSTSTOFF (SATZ)
7	917611 00000	LAGERDICHTRING
8	911472 00000	DISTANZSCHEIBE
9	906662 00000	WÄLZLAGER 6207 DIN 625
10	906576 00000	WELLENDICHTRING
11	912821 00000	VERSCHLUSSDECKEL
15	000801 26500	SEITENDECKEL
16	000702 26500	SEITENDECKEL
17	912871 00000	VERSCHLUSS-SCHRAUBE
18	902108 00000	KUPPLUNGSHÄLFTE
19	902210 00000	KUPPLUNGSSCHEIBE
21	945331 00000	INNENSECHSKANTSCHRAUBE
22	948742 00000	PASSKERBSTIFT
24	947733 00000	PASSFEDER
28	952008 00000	SPANNHÜLSE
30	502301 26400	VENTILATOR MIT NABE
31	947732 00000	PASSFEDER
32	945270 00000	WELLENENDSCHRAUBE
33	949409 00000	UNTERLEGSCHNEIBE
39	053200 26500	LATERNE
40	945321 00000	INNENSECHSKANTSCHRAUBE
41	537502 26400	RÜCKSCHLAGVENTIL, KOMPL.
46	008002 26400	SIEB
47	945371 00000	INNENSECHSKANTSCHRAUBE
49	951602 00000	RINGMUTTER
50	946969 00000	STIFTSCHRAUBE
52	951228 00000	VERSCHLUSS-SCHRAUBE
61	002406 26400	ABSCHIEDERGEHÄUSE
62	951221 00000	VERSCHLUSS-SCHRAUBE
64	001702 26400	ÖLBEHÄLTER-DECKEL
67	003704 26400	DECKEL
69	946968 00000	STIFTSCHRAUBE
70	917107 00000	TELLERFEDER
71	947105 00000	SECHSKANTMUTTER
74	305800 02000	ÜBERWURFMUTTER
76	727505 99628	ABBLASEVENTIL
83	965415 00000	LUFTEVENTILELEMENT (2x) ²⁾
89	921500 50000	HANDGRIFF
90	013300 26400	PRALLBLECH
91	945318 00000	INNENSECHSKANTSCHRAUBE
93	945226 00000	SECHSKANTSCHRAUBE
94	867800 99559	SCHWIMMER
95	003300 10700	DÜSE
98	912871 00000	VERSCHLUSS-SCHRAUBE
101	506000 26400	GROBABSCHIEDER, KOMPLETT
104	008001 26400	SIEB
105	952014 00000	SPANNHÜLSE
112	003703 26400	DECKEL
119	907309 00000	ÖLSCHAUGLAS
120	916800 10000	SCHRAUBDECKEL
124	947104 00000	SECHSKANTMUTTER
125	948504 00000	FEDERRING
126	951001 02000	STIFTSCHRAUBE
128	951003 02000	STIFTSCHRAUBE
130	945383 00000	INNENSECHSKANTSCHRAUBE
131	945230 00000	SECHSKANTSCHRAUBE



U 4.250

Pos.	Bestell Nr.	Beschreibung
132	945363 00000	INNENSECHSKANTSCHRAUBE
133	945321 00000	INNENSECHSKANTSCHRAUBE
134	945324 00000	INNENSECHSKANTSCHRAUBE
135	951220 00000	VERSCHLUSS-SCHRAUBE
141	012215 26400	LEITUNG
143	012202 26400	ÖLRÜCKFÜHRLEITUNG
144	012216 26400	LEITUNG
148	948402 00000	HOHLSCHRAUBE
152	009400 19000	KUGELSTÜCKSCHRAUBE
154	012900 19000	VERSCHLUSS-SCHRAUBE
156	912306 00000	ANSCHLUSS-SCHRAUBE
157	960201 26400	KÜHLER
159	012214 26400	LEITUNG
181	018301 26400	HAUBE
184	945127 00000	SECHSKANTSCHRAUBE
185	947506 00000	UNTERLEGSCHNEIBE
186	947106 00000	MUTTER
187	568100 26400	STÜTZE
188	949408 00000	U-SCHNEIBE
190	945227 00000	WELLENABSCHLUSS-SCHRAUBE
193	949203 00000	ZAHNSCHNEIBE
197	741302 00000	GUMMIPUFFER
198	945634 00000	GEWINDESTIFT
214	950700 10000	LÜSTERKLEMME
215	946304 00000	INNENSECHSKANTSCHRAUBE
216	943400 90000	TEMPERATURFÜHLER
218	902100 21900	MOTORKUPPLUNG Ø38mm
282	741103 99682	NIVEAUGEBER - OPTIONAL
313	902100 21300	MOTORKUPPLUNG (US)
314	945238 00000	SECHSKANTSCHRAUBE (US)
316	037900 10400	ZWISCHENFLANSCH (US)
406	768705 99626	GASBALLASTVENTIL - OPTIONAL

¹⁾ Dichtungssatz - 54900026400

- Pos.: 13, 25, 26, 44, 53, 63, 77, 79, 80, 118, 121, 129, 136, 149, 153, 283

²⁾ erforderliche Bestellmenge / Wartung

OPTIONAL

U 4.250 SA/K	-25	Sonderausführung - mit Öl-Wasser-Kühler
	-51	Sonderausführung - mit Ölbadheizung, Niveau-Geber und Thermostat
	-54	Sonderausführung - mit zusätzlicher Ölablassbohrung
U 4.250 F/K	-25	Sonderausführung - mit Öl-Wasser-Kühler
	-51	Sonderausführung - mit Ölbadheizung, Niveau-Geber und Thermostat

Abweichende Positionen zum Standardgerät - siehe Anhang (Zeichnungsrückseite)





U 4.250

Pos.	Ident No.	Description
...	549000 26400	GASKET SET ¹⁾
1	000101 26500	PUMP BODY
3	020000 26500	ROTOR
5	900507 00003	ROTOR VANE IN PLASTIC (KIT)
7	917611 00000	BEARING SEALING WASHER
8	911472 00000	DISTANCE DISC
9	906662 00000	BEARING 6207 DIN 625
10	906576 00000	SHAFT SEALING RING
11	912821 00000	CAP
15	000801 26500	LID
16	000702 26500	LID
17	912871 00000	LOCKING SCREW
18	902108 00000	COUPLING
19	902210 00000	COUPLING DISC
21	945331 00000	SOCKET HEAD SCREW
22	948742 00000	STRAIGHT PIN
24	947733 00000	KEY
28	952008 00000	LOCATING PEG
30	502301 26400	FAN
31	947732 00000	KEY
32	945270 00000	SHAFT END BOLD
33	949409 00000	WASHER
39	053200 26500	CONNECTION FLANGE
40	945321 00000	SOCKET HEAD SCREW
41	537502 26400	NON RETURN VALVE, ENTIRE
46	008002 26400	SIEVE
47	945371 00000	SOCKET HEAD SCREW
49	951602 00000	RING UNIT
50	946969 00000	STUD
52	951228 00000	LOCKING SCREW
61	002406 26400	HOUSING FOR OIL SEPARATION
62	951221 00000	LOCKING SCREW
64	001702 26400	OIL TANK COVER
67	003704 26400	COVER
69	946968 00000	STUD
70	917107 00000	SPRING COLLAR
71	947105 00000	HEX.NUT
74	305800 02000	COUPLING NUT
76	727505 99628	BLOW OFF VALVE
83	965415 00000	OIL SEPARATION ELEMENT (2x) ²⁾
89	921500 50000	HANDLE
90	013300 26400	METAL FILTER
91	945318 00000	SOCKET HEAD SCREW
93	945226 00000	HEX. HEAD SCREW
94	867800 99559	FLOAT
95	003300 10700	NOZZLE
98	912871 00000	LOCKING SCREW
101	506000 26400	COARSE SEPARATOR
104	008001 26400	SIEVE
105	952014 00000	FIXING SLEEVE
112	003703 26400	COVER
119	907309 00000	OIL SIGHT GLASS
120	916800 10000	COVER
124	947104 00000	HEX.NUT
125	948504 00000	SPRING WASHER
126	951001 02000	STUD
128	951003 02000	STUD
130	945383 00000	SOCKET HEAD SCREW
131	945230 00000	HEX. HEAD SCREW



U 4.250

Pos.	Ident No.	Description
132	945363 00000	SOCKET HEAD SCREW
133	945321 00000	SOCKET HEAD SCREW
134	945324 00000	SOCKET HEAD SCREW
135	951220 00000	LOCKING SCREW
141	012215 26400	PIPE
143	012202 26400	OIL RETURN PIPE
144	012216 26400	PIPE
148	948402 00000	HOLLOW SCREW
152	009400 19000	HOLLOW HOLDING SCREW
154	012900 19000	LOCKING SCREW
156	912306 00000	CONNECTING SCREW
157	960201 26400	COOLER
159	012214 26400	PIPE
181	018301 26400	PROTECTING HOOD
184	945127 00000	HEX-HEAD SCREW
185	947506 00000	WASHER
186	947106 00000	NUT
187	568100 26400	SUPPORT PILLAR
188	949408 00000	WASHER
190	945227 00000	SCREW
193	949203 00000	TOOTHED SPRING WASHER
197	741302 00000	RUBBER BUFFER
198	945634 00000	THREADED PIN
214	950700 10000	LUSTER TERMINAL
215	946304 00000	SOCKET HEAD SCREW
216	943400 90000	TEMPERATURE PROBE
218	902100 21900	COUPLING MOTOR SIDE Ø38mm
282	741103 99682	OIL LEVEL CONTROL - OPTIONAL
313	902100 21300	COUPLING MOTOR SIDE (US)
314	945238 00000	HEX-HEAD SCREW (US)
316	037900 10400	INTERMEDIATE FLANGE (US)
406	768705 99626	GAS BALLAST VALVE - OPTIONAL



¹⁾ Set of seals - 54900026400
 - Pos.: 13, 25, 26, 44, 53, 63, 77, 79, 80, 118, 121, 129, 136, 149, 153, 283
²⁾ necessary order quantity / maintenance

OPTIONAL

U 4.250 SA/K	-25	Special design – with oil-to-water heat exchanger
	-51	Special design – with oil bath heating, level transmitter and heat valve
	-54	Special design – with additional oil draining bore hole
U 4.250 F/K	-25	Special design – with oil-to-water heat exchanger
	-51	Special design – with oil bath heating, level transmitter and heat valve

Items different from standard appliance see appendix (back of drawing)

Pos.	No. Identification	Designation
...	549000 26400	JEU DE JOINTS ¹⁾
1	000101 26500	CORP DE POMPE
3	020000 26500	PISTON
5	900507 00003	PALETTE ON PLASTIQUE (KIT)
7	917611 00000	RONDELLE D'ETANCHEITE DU ROULEMENT
8	911472 00000	DISQUE AJUSTAGE
9	906662 00000	ROULEMENT 6207 DIN 625
10	906576 00000	BAGUE D'ETANCHEITE P.L'AXE
11	912821 00000	COUVERCLE
15	000801 26500	COUVERCLE
16	000702 26500	COUVERCLE
17	912871 00000	BOUCHON
18	902108 00000	ACCOUPEMENT
19	902210 00000	DISQUE D'ACCOUPEMENT
21	945331 00000	VIS HEXAGONALE INTERNE
22	948742 00000	GOUPILLE CYLINDRIQUE
24	947733 00000	CLAVETTE
28	952008 00000	DOVILLE DE ETRAGE
30	502301 26400	VENTILATEUR
31	947732 00000	CLAVETTE
32	945270 00000	VIS BOUT D'ARBRE
33	949409 00000	RONDELLE
39	053200 26500	BRIDE DE RACCORDEMENT
40	945321 00000	VIS HEXAGONALE INTERNE
41	537502 26400	SOUPAPE ANTI-RETOUR, ENTIER
46	008002 26400	FILTRE
47	945371 00000	VIS HEXAGONALE INTERNE
49	951602 00000	ECROU A ANNEAU
50	946969 00000	PRISONNIER
52	951228 00000	BOUCHON
61	002406 26400	CORP DE SEPARATEUR D'HUILE
62	951221 00000	BOUCHON
64	001702 26400	COUVERCLE RESERVOIR D'HUILE
67	003704 26400	COUVERCLE
69	946968 00000	PRISONNIER
70	917107 00000	RONDELLE A RESSORT
71	947105 00000	ECROU A 6 PANS
74	305800 02000	ECROU
76	727505 99628	SILENCIEUX
83	965415 00000	ELEMENT SEPARATION HUILE (2x) ²⁾
89	921500 50000	POIGNEE
90	013300 26400	FILTRE METALIQUE
91	945318 00000	VIS HEXAGONALE INTERNE
93	945226 00000	VIS HEXAGONALE
94	867800 99559	PIED CAOUTCHOVE
95	003300 10700	GICLEUR
98	912871 00000	BOUCHON
101	506000 26400	SEPARATEUR A GROS
104	008001 26400	FILTRE
105	952014 00000	MANCHON DE FIXATION
112	003703 26400	COUVERCLE
119	907309 00000	VERRE REGARD
120	916800 10000	COUVERCLE
124	947104 00000	ECROU A 6PANS
125	948504 00000	ANNEAU-RESSORT
126	951001 02000	PRISONNIER
128	951003 02000	PRISONNIER
130	945383 00000	VIS HEXAGONALE INTERNE
131	945230 00000	VIS HEXAGONALE

Pos.	No. Identification	Designation
132	945363 00000	VIS HEXAGONALE INTERNE
133	945321 00000	VIS HEXAGONALE INTERNE
134	945324 00000	VIS HEXAGONALE INTERNE
135	951220 00000	BOUCHON
141	012215 26400	TUYAU
143	012202 26400	TUYAU D'HUILE
144	012216 26400	TUYAU
148	948402 00000	VIS CREUSE
152	009400 19000	VIS CREUSE DE FIXATION
154	012900 19000	BUCHON
156	912306 00000	VIS DE RACCORD
157	960201 26400	REFROIDISSEUR
159	012214 26400	TUYAU
181	018301 26400	CARTER PROTECTEUR
184	945127 00000	VIS HEXAGONALE
185	947506 00000	RONDELLE
186	947106 00000	ECROU
187	568100 26400	SUPPORT INTERMEDIAIRE
188	949408 00000	RONDELLE
190	945227 00000	VIS
193	949203 00000	DENT DISQUE
197	741302 00000	AMORTISSEUR EN CAOUTCHOUC
198	945634 00000	GOUPILLE FILETEE
214	950700 10000	SERRE-FILS
215	946304 00000	VIS HEXAGONALE INTERNE
216	943400 90000	PALPEUR DE TEMPERATURE
218	902100 21900	ACCOUPEMENT MOTEUR Ø38mm
282	741103 99682	INDICATEUR DE NIVEAU - EN OPTION
313	902100 21300	ACCOUPEMENT MOTEUR (US)
314	945238 00000	VIS HEXAGONALE (US)
316	037900 10400	BRIDE INTERMEDIAIRE (US)
406	768705 99626	L'ESTE D'AIR - EN OPTION

¹⁾ Jeu de joints - 54900026400

- Pos.: 13, 25, 26, 44, 53, 63, 77, 79, 80, 118, 121, 129, 136, 149, 153, 283

²⁾ quantité nécessaire / entretien

EN OPTION

U 4.250 SA/K	-25	Fabrication spéciale – avec réfrigérant à l'huile et à l'eau
	-51	Fabrication – avec chauffage du bain d'huile, capteur de niveau et thermostat
	-54	Fabrication spéciale – avec trou de vidange d'huile
U 4.250 F/K	-25	Fabrication spéciale – avec réfrigérant à l'huile et à l'eau
	-51	Fabrication – avec chauffage du bain d'huile, capteur de niveau et thermostat

Articles divergents vis-à-vis de l'appareil standard, voir annexe (dos du dessin / du plan)

Pos.	No. Identificazione	Designazione
...	549000 26400	KIT GUARNIZIONI ¹⁾
1	000101 26500	CARCASSA
3	020000 26500	ROTORE
5	900507 00003	PALETTE IN PLASTICA (KIT)
7	917611 00000	ANELLO DI TENUTA DEL CUSCINETTO
8	911472 00000	DISCO DISTANZA
9	906662 00000	CUSCINETTO 6207 DIN 625
10	906576 00000	GUARNIZIONE PER L'ALBERO
11	912821 00000	COPERCHIO
15	000801 26500	COPERCHIO
16	000702 26500	COPERCHIO
17	912871 00000	VITE DI CHIUSURA
18	902108 00000	GIUNTO
19	902210 00000	DISCO GUINTO
21	945331 00000	VITE ESAGONALE INTERNA
22	948742 00000	PERNO
24	947733 00000	CHIAVETTA
28	952008 00000	SPINE DI RISCONTRO
30	502301 26400	VENTILATORE
31	947732 00000	CHIAVETTA
32	945270 00000	VITE DI CHIUSURA ALBERO
33	949409 00000	RONDELLA
39	053200 26500	FLANGIA DI RACCORDE
40	945321 00000	VITE ESAGONALE INTERNA
41	537502 26400	VALVOLA NON RITORNO, INTERO
46	008002 26400	FILTRO
47	945371 00000	VITE ESAGONALE INTERNA
49	951602 00000	GOLFARE CON FORO FILETTATO
50	946969 00000	L'ASTA A VITE
52	951228 00000	VITE DI CHIUSURA
61	002406 26400	CARCASSA SEPARATORE OLIO
62	951221 00000	VITE DI CHIUSURA
64	001702 26400	COPERCHIO SERBATOIO OLIO
67	003704 26400	COPERCHIO
69	946968 00000	L'ASTA A VITE
70	917107 00000	RONDELLA A MOLLA
71	947105 00000	DADO ESAGONALE
74	305800 02000	DADO DI RISVOLTO
76	727505 99628	SILENZIATORE
83	965415 00000	CARTUCCIA SEPARATORE OLIO (2x) ²⁾
89	921500 50000	MANETTA
90	013300 26400	FILTRO METALICO
91	945318 00000	VITE ESAGONALE INTERNA
93	945226 00000	VITE ESAGONALE
94	867800 99559	GALLEGGIANTE
95	003300 10700	UGELLO
98	912871 00000	VITE DI CHIUSURA
101	506000 26400	SEPARATORE GROSSOLANO
104	008001 26400	FILTRO
105	952014 00000	MANICOTTO DI FISSAZIONE
112	003703 26400	COPERCHIO
119	907309 00000	SPIA LIVELLO OLIO
120	916800 10000	COPERCHIO
124	947104 00000	DADO ESAGONALE
125	948504 00000	ANELLO A MOLLA
126	951001 02000	L'ASTA A VITE
128	951003 02000	L'ASTA A VITE
130	945383 00000	VITE ESAGONALE INTERNA
131	945230 00000	VITE ESAGONALE

Pos.	No. Identificazione	Designazione
132	945363 00000	VITE ESAGONALE INTERNA
133	945321 00000	VITE ESAGONALE INTERNA
134	945324 00000	VITE ESAGONALE INTERNA
135	951220 00000	VITE DI CHIUSURA
141	012215 26400	CONDOTTO
143	012202 26400	CONDOTTO OLIO
144	012216 26400	CONDOTTO
148	948402 00000	VITE ESAGONALE
152	009400 19000	VITE PASSAGGIO OLIO
154	012900 19000	VITE DI CHIUSURA
156	912306 00000	ATTACO FILETTATO
157	960201 26400	RAFFREDDATORE
159	012214 26400	CONDOTTO
181	018301 26400	CARTER DI PROTEZIONE
184	945127 00000	VITE ESAGONALE
185	947506 00000	RONDELLA
186	947106 00000	DADO
187	568100 26400	SUPPORTO
188	949408 00000	RONDELLA
190	945227 00000	VITE
193	949203 00000	DISCO A DENTE
197	741302 00000	AMMORTIZZATORE IN GOMMA
198	945634 00000	SPINA FILETTATURA
214	950700 10000	SCATOLA DEI CONNETTORI
215	946304 00000	VITE ESAGONALE INTERNA
216	943400 90000	TASTATORE TEMPERATURE
218	902100 21900	GIUNTO MOTORE Ø38mm
282	741103 99682	SONDA D'OLIO - OPTIONALE
313	902100 21300	GIUNTO MOTORE (US)
314	945238 00000	VITE ESAGONALE (US)
316	037900 10400	FLANGE INTERMEDIA (US)
406	768705 99626	VALVOLA DI ZAVORATRICE - OPTIONALE

¹⁾ Serie di guarnizione - 54900026400

- Pos.: 13, 25, 26, 44, 53, 63, 77, 79, 80, 118, 121, 129, 136, 149, 153, 283

²⁾ quantità di ordinazione necessari / manutenzione

OPTIONALE

U 4.250 SA/K	-25	Modello speciale - con radiatore ad olio - acqua
	-51	Modello - con riscaldamento a bagno d'olio, indicatore di livello e termostato
	-54	Modello speciale - con faro di scarico dell'olio aggiuntivo
U 4.250 F/K	-25	Modello speciale - con radiatore ad olio - acqua
	-51	Modello - con riscaldamento a bagno d'olio, indicatore di livello e termostato

Vedere allegato (retro del disegno) per le posizioni divergenti dall'apparecchio standard 



U 4.250

Pos.	No. De pedido	Descripción	
...	549000 26400	JUEGO DE JUNTA ¹⁾	
1	000101 26500	CARCASA	
3	020000 26500	ÉMBOLO	
5	900507 00003	EMPUJADOR DE PLÁSTICO (KIT)	
7	917611 00000	ANILLO DE COJINETE DE JUNTA	
8	911472 00000	ARANDELA DISTANCIADORA	
9	906662 00000	COJINETE DE RODAMIENTO 6207 DIN 625	
10	906576 00000	ANILLO DE JUNTA DE ÁRBOL	
11	912821 00000	TAPA DE CIERRE	
15	000801 26500	TAPA LATERAL	
16	000702 26500	TAPA LATERAL	
17	912871 00000	TORNILLO DE CIERRE	
18	902108 00000	MITAD DE ACOPLAMIENTO	
19	902210 00000	DISCO DE ACOPLAMIENTO	
21	945331 00000	TORNILLO HEXAGONAL INTERIOR	
22	948742 00000	PASADOR ENTALLADO DE AJUSTE	
24	947733 00000	LENGÜETA DE AJUSTE	
28	952008 00000	CASQUILLO TENSOR	
30	502301 26400	VENTILADOR CON CUBO	
31	947732 00000	LENGÜETA DE AJUSTE	
32	945270 00000	TORNILLO TERMINAL DE ÁRBOL	
33	949409 00000	ARANDELA	
39	053200 26500	FAROL	
40	945321 00000	TORNILLO HEXAGONAL INTERIOR	
41	537502 26400	VÁLVULA ANTIRRETORNO COMPLETA	
46	008002 26400	CRIBA	
47	945371 00000	TORNILLO HEXAGONAL INTERIOR	
49	951602 00000	TUERCA DE CÁNCAMO	
50	946969 00000	ESPÁRRAGO	
52	951228 00000	TORNILLO DE CIERRE	
61	002406 26400	CARCASA SEPARADORA	
62	951221 00000	TORNILLO DE CIERRE	
64	001702 26400	TAPA DE RECIPIENTE DE ACEITE	
67	003704 26400	TAPA	
69	946968 00000	ESPÁRRAGO	
70	917107 00000	ARANDELA DE APOYO DEL RESORTE	
71	947105 00000	TUERCA HEXAGONAL	
74	305800 02000	SOBRETUERCA	
76	727505 99628	VÁLVULA DE BARRIDO	
83	965415 00000	ELEMENTO DE DESACEITAR DE AIRE (2x) ²⁾	
89	921500 50000	EMPUÑADURA	
90	013300 26400	CHAPA DE REBOTE	
91	945318 00000	TORNILLO HEXAGONAL INTERIOR	
93	945226 00000	TORNILLO DE CABEZA HEXAGONAL	
94	867800 99559	FLOTADOR	
95	003300 10700	TOBERA	
98	912871 00000	TORNILLO DE CIERRE	
101	506000 26400	SEPARADOR DE SÓLIDOS GRUESOS COMPLETO	
104	008001 26400	CRIBA	
105	952014 00000	MANGUITO DE FIJACIÓN	
112	003703 26400	TAPA	
119	907309 00000	CRISTAL MIRILLA DE ACEITE	
120	916800 10000	TAPA ROSCADA	
124	947104 00000	TUERCA HEXAGONAL	
125	948504 00000	ARANDELA DE MUELLE	
126	951001 02000	ESPÁRRAGO	
128	951003 02000	ESPÁRRAGO	
130	945383 00000	TORNILLO HEXAGONAL INTERIOR	
131	945230 00000	TORNILLO HEXAGONAL	



U 4.250

Pos.	No. De pedido	Descripción	
132	945363 00000	TORNILLO HEXAGONAL INTERIOR	
133	945321 00000	TORNILLO HEXAGONAL INTERIOR	
134	945324 00000	TORNILLO HEXAGONAL INTERIOR	
135	951220 00000	TORNILLO DE CIERRE	
141	012215 26400	CONDUCTO	
143	012202 26400	CONDUCTO DE RETROALIMENTACIÓN DE ACEITE	
144	012216 26400	CONDUCTO	
148	948402 00000	TORNILLO HUECO	
152	009400 19000	TORNILLO DE PIEZA ESFÉRICA	
154	012900 19000	TORNILLO DE CIERRE	
156	912306 00000	TORNILLO DE EMPALME	
157	960201 26400	REFRIGERADOR	
159	012214 26400	CONDUCTO	
181	018301 26400	SOMBRERETE	
184	945127 00000	TORNILLO DE CABEZA HEXAGONAL	
185	947506 00000	ARANDELA	
186	947106 00000	TUERCA	
187	568100 26400	APOYO	
188	949408 00000	ARANDELA	
190	945227 00000	TORNILLO TERMINAL DE ÁRBOL	
193	949203 00000	POLEA DENTADA	
197	741302 00000	AMORTIGUADOR DE GOMA	
198	945634 00000	VARILLA ROSCADA	
214	950700 10000	CAJA DE CONEXIÓN	
215	946304 00000	TORNILLO HEXAGONAL INTERIOR	
216	943400 90000	SENSOR DE TEMPERATURA	
218	902100 21900	ACOPLAMIENTO DE MOTOR Ø38mm	
282	741103 99682	GENERADOR DE NIVEL - OPCIONAL	
313	902100 21300	ACOPLAMIENTO DE MOTOR (US)	
314	945238 00000	TORNILLO DE CABEZA HEXAGONAL (US)	
316	037900 10400	BRIDA INTERMEDIA (US)	
406	768705 99626	VÁLVULA DE LASTRE DE GAS - OPCIONAL	

¹⁾ Junta completa - 549000026400

- Pos.: 13, 25, 26, 44, 53, 63, 77, 79, 80, 118, 121, 129, 136, 149, 153, 283

²⁾ cantidad necesario / mantenimiento

OPCIONAL

U 4.250 SA/K	-25	Versión especial – con refrigerador aceite-agua
	-51	Versión – con calefacción de baño de aceite, codificador de nivel y termostato
	-54	Versión especial – con perforación de salida de aceite adicional
U 4.250 F/K	-25	Versión especial – con refrigerador aceite-agua
	-51	Versión – con calefacción de baño de aceite, codificador de nivel y termostato

Para posiciones que derivan del aparato standard véase apéndice (lado trasero del plano)

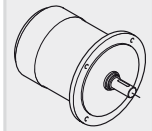

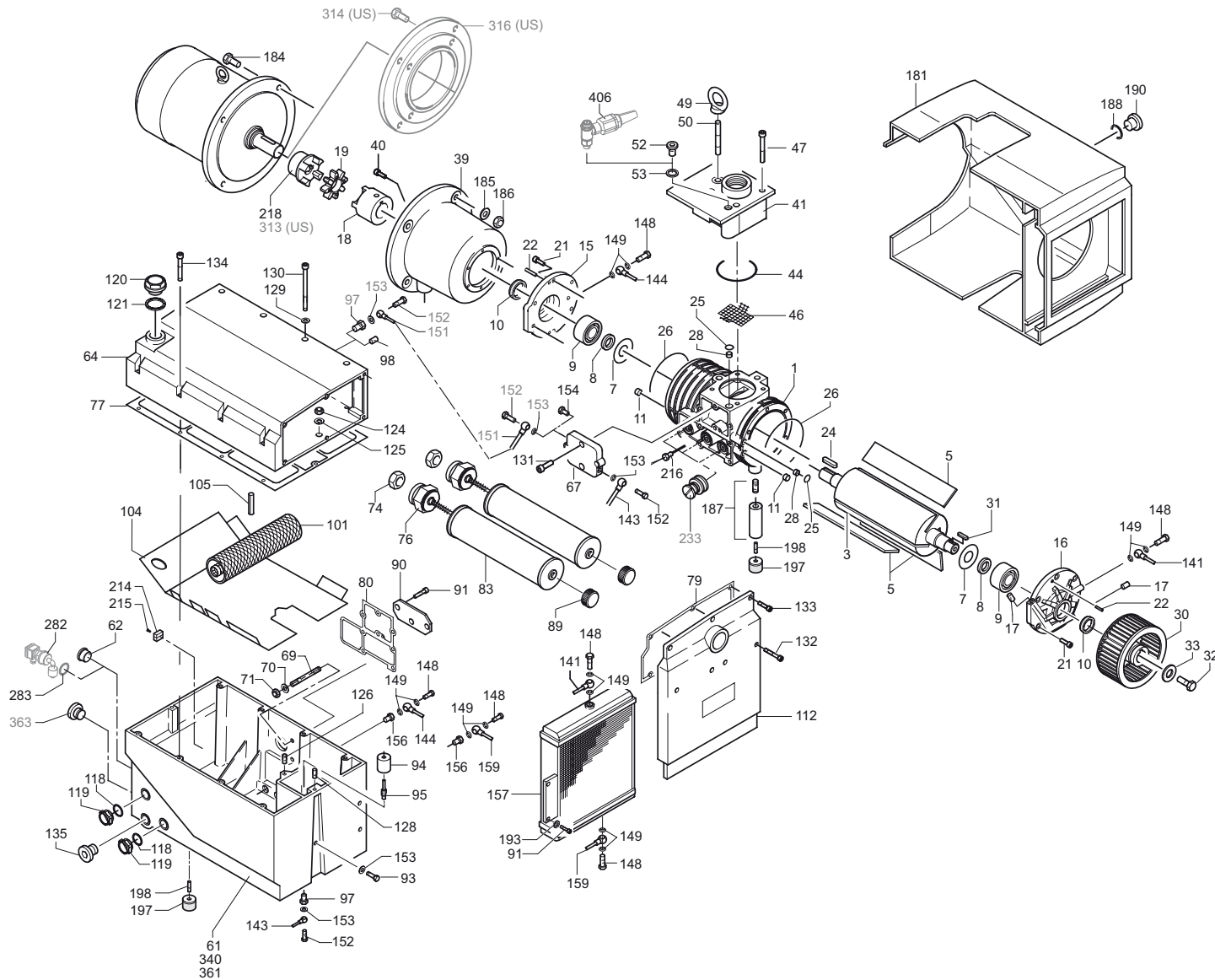
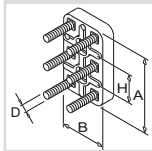
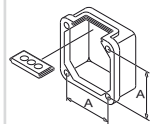
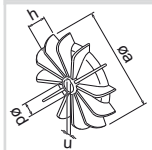
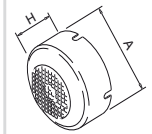

SERVICE ?



standard

U 4.250 SA/K
U 4.250 F/K

optional
en option
opcionale
opcional

optional en option optionale opcional 	Variante(n) Modifications Variantes	Pos ³⁾	Bestell Nr. / Ident No. / No. Identification / No. Identificazione / No. De pedido		Beschreibung / Description / Designation / Designazione / Descripcion
					
U 4.250 SA/K-XX U 4.250 F/K-XX	U 4.250 F/K	97 98 151 152 153 154 233	912300 00000 012203 26400 009400 19000 948002 00000 537503 26400	 912874-00000 012900-19000	ANSCHLUSSSCHRAUBE / CONNECTING SCREW / VIS DE RACCORD / ATTACO FILETTATO / TORNILLO DE EMPALME VERSCHLUSSSCHRAUBE / LOCKING SCREW / BOUCHON / VITE DI CHIUSURA / TORNILLO DE CIERRE LEITUNG / OIL SUCTION PIPE / TUYAU D'HUILE / CONDOTTO OLIO / CONDUCTO DE ASPIRACIÓN DE ACEITE KUGELSTÜCKSCHRAUBE / HOLLOW HOLDING SCREW / VIS CREUSE DE FIXATION / VITE PASSAGGIO OLIO / TORNILLO DE PIEZA ESFÉRICA DICHTUNG / GASKET / JOINT / GUARNIZIONE / JUNTA VERSCHLUSSSCHRAUBE / LOCKING SCREW / BOUCHON / VITE DI CHIUSURA / TORNILLO DE CIERRE VENTIL, KOMPL. / VALVE, ENTIRE / SOUPAPE, ENTIER / VALVOLA, INTERO / VÁLVULA COMPLETA
	U 4.250 SA/K - 25 U 4.250 F/K - 25	91 141 142 144 145 146 156 157 159 181 193 203 204 205 206 208 209	 012210 26400 012211 26400 012202 26500 012213 26400 912301 00000 960204 26200 969438 00000 935200 10000 969401 00009 018303 26400 922401 20000	945318-00000 012215-26400 012216-26400 912306-00000 960204-26400 012214-26400 018304-26400 949203-00000	INNENSECHSKANTSCHRAUBE / ALLEN SCREW / VIS ALLEN / VITE ESAGONALE INTERNA / TORNILLO HEXAGONAL INTERIOR LEITUNG / PIPE / TUYAU / CONDOTTO / CONDUCTO LEITUNG / PIPE / TUYAU / CONDOTTO / CONDUCTO LEITUNG / PIPE / TUYAU / CONDOTTO / CONDUCTO LEITUNG / PIPE / TUYAU / CONDOTTO / CONDUCTO LEITUNG / PIPE / TUYAU / CONDOTTO / CONDUCTO ANSCHLUSSSCHRAUBE / CONNECTING SCREW / VIS DE RACCORD / ATTACO FILETTATO / TORNILLO DE EMPALME KÜHLER / COOLER / REFROIDISSEUR / RAFFREDDATORE / REFRIGERADOR LEITUNG / PIPE / TUYAU / CONDOTTO / CONDUCTO HAUBE / PROTECTING HOOD / CARTER PROTECTEUR / CARTER DI PROTEZIONE / SOMBRETERE ZAHNSCHEIBE / TOOTHED LOCK WASHER / RONDELLE À DENTS / RONDELLA DENTATA / ARANDELA DENTADA KUEHLER / COOLER / REFROIDISSEUR / RAFFREDDATORE / REFRIGERADOR L-VERSCHRAUBUNG / L-PIECE / L-PIECE / PEZZO A L / ATORNILLADURA VERLÄNGERUNG / ADAPTOR / RACCORD INTERMÉDIAIRE / RACCORDO INTERMEDIO / ADAPTADOR SCHLAUCH / FLEXIBLE HOSE / TUYAUTERIE FLEXIBLE / TUBAZIONE FLESSIBILE / TUBERÍA FLEXIBLE HAUBE / PROTECTING HOOD / CARTER PROTECTEUR / CARTER DI PROTEZIONE / SOMBRETERE SCHUTZGITTER / SAFETY GUARD / GRILLAGE DE PROTECTION / GABBIA DI PROTEZIONE / REJILLA DE PROTECCIÓN
	U 4.250 SA/K - 51 U 4.250 F/K - 51	61 62 282 283 340 341 342 343 344 345	 741103 99682 948086 00000 002408 26400 960202 26400 943400 70000 948070 00000 913116 00100 948011 00000	002406-26400 951221-00000	ÖLABSCHEIDERGEHÄUSE / HOUSING FOR OIL SEPARATION / CARCASSE POUR SEPARATION D'HUILE / CARCASSA SEPARATORE OLIO / CARCASA SEPARADORA DE ACEITE VERSCHLUSSSCHRAUBE / LOCKING SCREW / BOUCHON / VITE DI CHIUSURA / TORNILLO DE CIERRE NIVEAUGEBER / LEVEL TRANSMITTER / CAPTEUR DE NIVEAU / INDICATORE DI LIVELLO / CODIFICADOR DE NIVEL DICHTRING / SEALING RING / JOINT / ANELLO / ANILLO ÖLABSCHEIDERGEHÄUSE / HOUSING FOR OIL SEPARATION / CARCASSE POUR SEPARATION D'HUILE / CARCASSA SEPARATORE OLIO / CARCASA SEPARADORA DE ACEITE ROHRHEIZKÖRPER / PIPE HEATER / CORPS DE CHAUFFE / SCALDIGLIA / CALEFACTOR TUBULAR TEMPERATUR-WÄCHTER / THERMOSTAT / THERMOSTAT / INTERRUPTORE TERMICO / TERMOSTATO KUPFERRING / SEALING RING / JOINT / ANELLO / ANILLO O-RING / O-RING SEAL / JOINT TORIQUE / GIUNTO CILINDRICO DI TENUTA / JUNTA TOROIDAL DICHTRING / SEALING RING / JOINT / ANELLO / ANILLO
	U 4.250 SA/K - 54	61 361 363	 002407 26400 951220 00100	002406-26400	ÖLABSCHEIDERGEHÄUSE / HOUSING FOR OIL SEPARATION / CARCASSE POUR SEPARATION D'HUILE / CARCASSA SEPARATORE OLIO / CARCASA SEPARADORA DE ACEITE ÖLABSCHEIDERGEHÄUSE / HOUSING FOR OIL SEPARATION / CARCASSE POUR SEPARATION D'HUILE / CARCASSA SEPARATORE OLIO / CARCASA SEPARADORA DE ACEITE VERSCHLUSSSCHRAUBE / LOCKING SCREW / BOUCHON / VITE DI CHIUSURA / TORNILLO DE CIERRE

³⁾ variantenabhängige Bauteile / variant-dependent components / composants variante-dependantes / componenti variante-dispendenti / componentes variante-dependientes

